







**Fitting for 2 wooden or metal shutters up to 140 kg (309 lbs.), with screwed on running track. Ceiling or architrave mounting.**

**Product highlights**

-  **Aesthetics** Attractive design solution for exciting and modern façade design
-  **Security** The shutters withstand even stormy winds, both open and closed

**Technical specifications**

-  Max. 140 kg (309 lbs)
-  Max. 3200 mm (10' 5 31/32")
-  700–1200 mm (2' 3 9/16" to 3' 11 1/4")  
(Max. shutter area 3.84 m<sup>2</sup> (41 ft<sup>2</sup>))
-  28–40 mm (1 3/32" to 1 9/16")

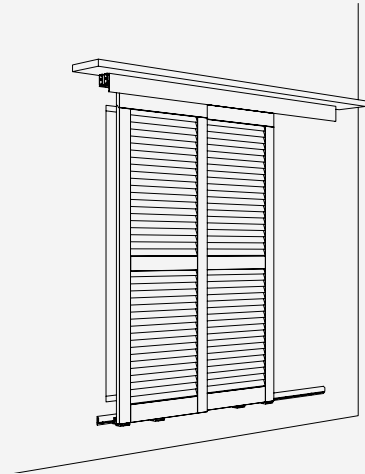



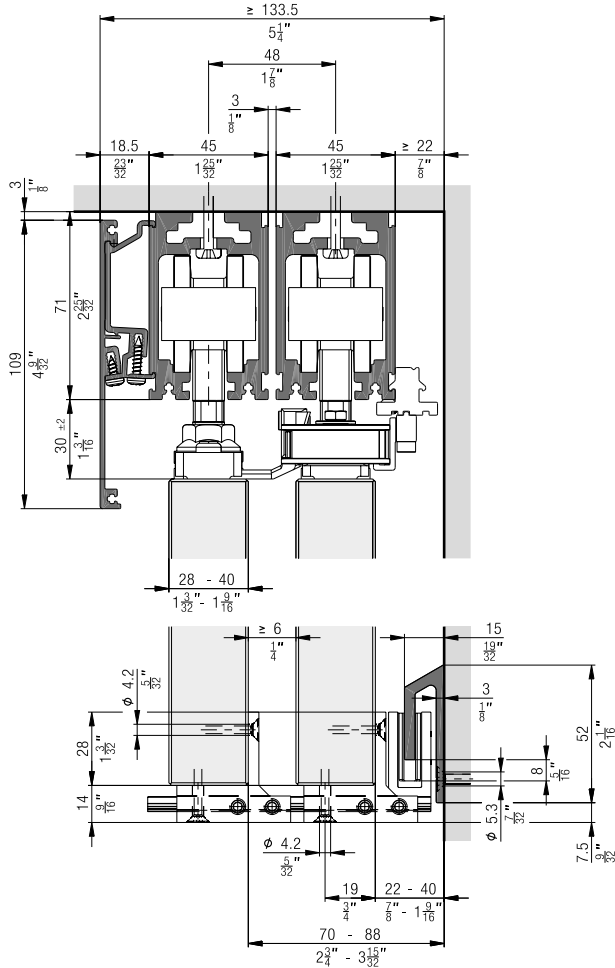



**Installation examples**

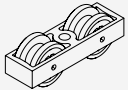
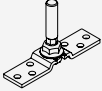
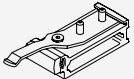

**Set for 2 sliding shutters up to 140 kg (309 lbs.)**

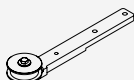
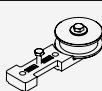
	No.
Hawa Frontslide 140 A Telescopic, for 2 sliding shutters	25131

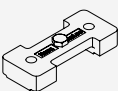
**Set consisting of:**

	25131	No.
 Two-wheeled running gear, M12, plastic wheels	4	24554
 Top fixing plate, stainless steel, with hanger bolt M12	4	24567
 Track stop with adjustable retainer	2	24835
 Toothed belt clamp	1	25060
 Guide pulley wheel, with fixing plate, long	1	20139
 Guide pulley wheel, with fixing plate, short	1	20140
 Driver, wide	1	20141
 Driver counter-plate, wide	1	20246
 Toothed belt, 2.7 m (8'10 5/16"), fibre glass reinforced, black	1	20208

**Running tracks**

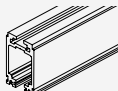
	mm (inch)	No.
	3500 (11' 5 25/32")	24841
	6000 (19' 8 7/32")	24799
	cut to size	24800

**Connecting pins for running tracks**

	No.
 Connecting bolts, 6-piece set	17221

**Guide tracks**

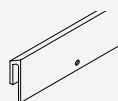
	mm (inch)	No.
	6000 (19' 8 7/32")	24460
	cut to size	24462

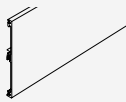
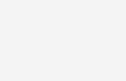

**Panels**

	mm (inch)	No.
	3500 (11' 5 25/32")	24845
	6000 (19' 8 7/32")	24808
	cut to size	24809
	6000 (19' 8 7/32")	24810
	cut to size	24811

**Panel attachment components**

	No.
 Parts for fitting running track cover, at least every 500 mm (1' 7 11/16"), 5-piece set	24767

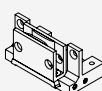
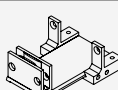
**Guides**

	No.
 Floor guide unit, short, for guide track	24543
 Floor guide unit, long, for guide track	24544
 Guide slider, for screw fixing	24542

Panel attachment component installation

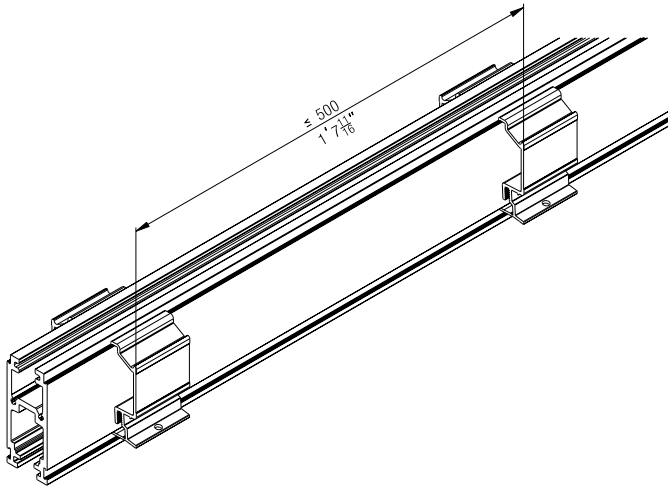

Sliding shutter width calculations

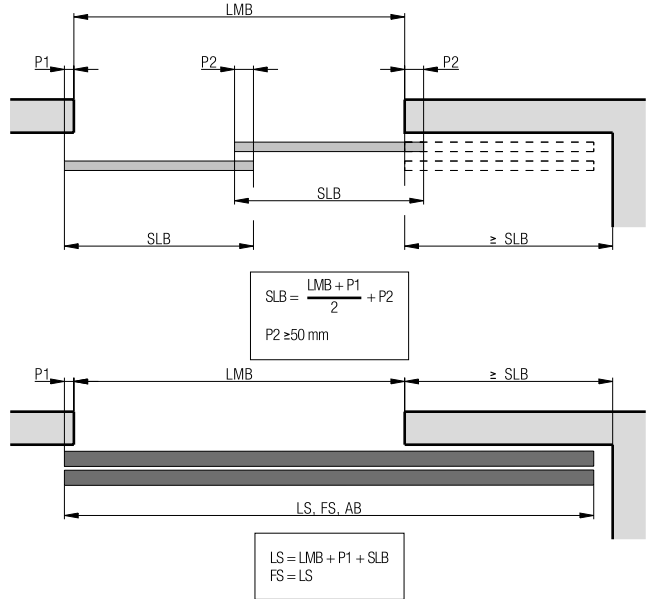

- AB = System width
- LMB = Inside clearance
- SLB = Sliding shutter width
- P = Sliding shutter overlap
- LS = Running track
- FS = Guide track

Suspension points

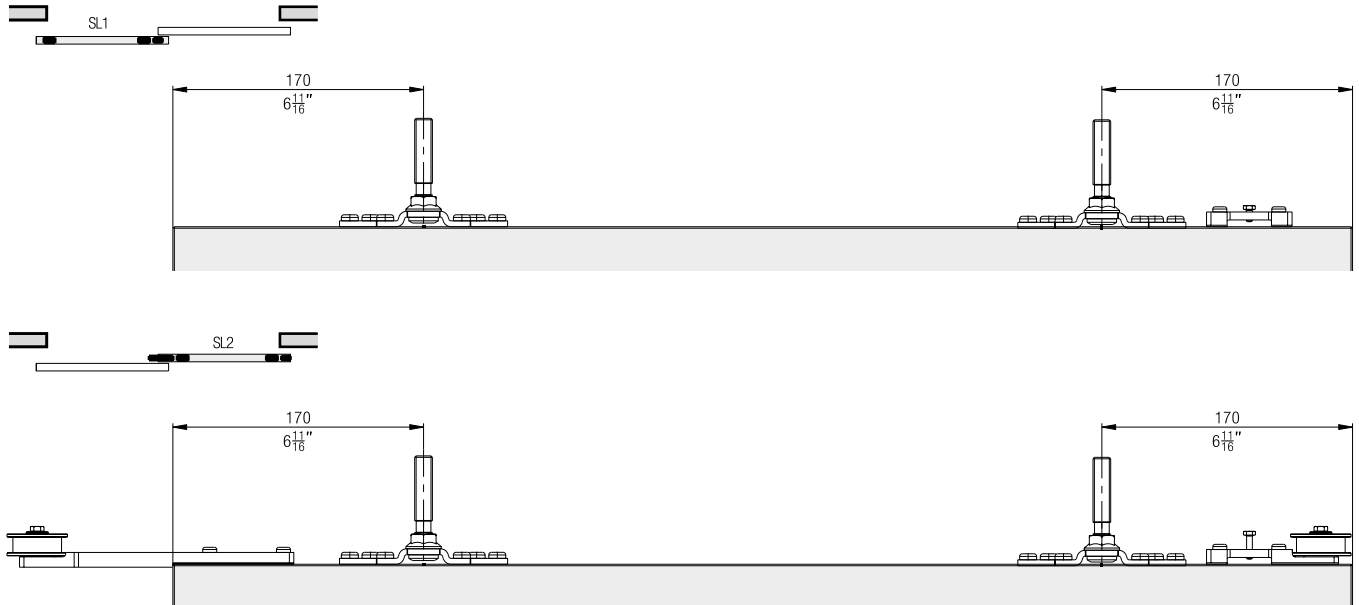

**Guides**

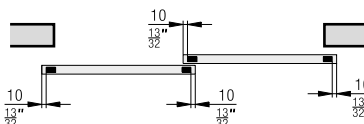
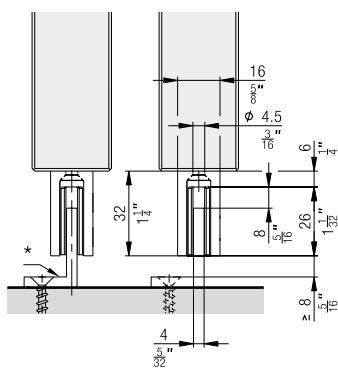
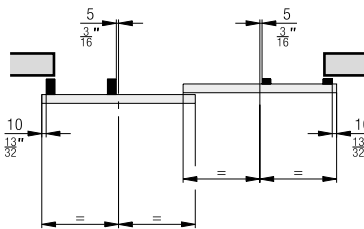
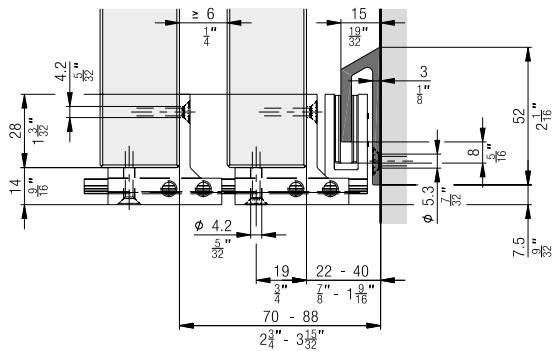

\* to be provided by customer

**Accessories**

- Sliding shutter bolts from page 190

**Planning/execution**

- Corrosion resistance class 4 in accordance with EN 1670 (very good resistance)
- Wind resistance class overview from page 198

Further information about the product can be found on [www.hawa.com](http://www.hawa.com).